

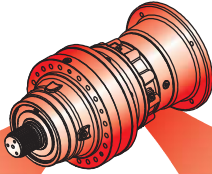

TEKNİK VERİLER / TECHNICAL DATA / TECHNISCHE DATEN / DATI TECNICI / DONNÉES TECHNIQUES / DATOS TÉCNICAS

	i_{ges}	M_{2max} (n1: 1400rpm) (Nm)
5001	3.78 ... 7.25	2140
5002	13.4 ... 48.9	2790
5003	52.1 ... 330.3	3750
5004	352.0 ... 1845.3	5310



OUTPUT

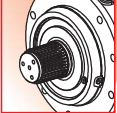

Ø65

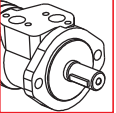

58X53
DIN 5482

INPUT

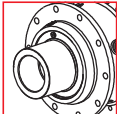

Ø28 - Ø42
Ø65 - Ø1"3/8

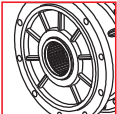

Hydraulic
Motor

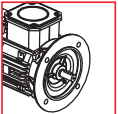

Ø75

58X53
DIN 5482

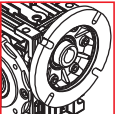
PL

Electric
Motor



Worm
gearboxes

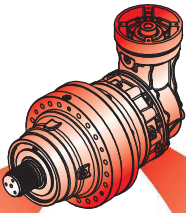

Brake

	i_{ges}	M_{2max} (n1: 1400rpm) (Nm)
5002	13.1 ÷ 39.5	2890
5003	39.4 ÷ 143.5	3360
5004	140.1 ÷ 1244.1	4580

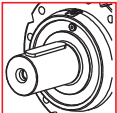

OUTPUT

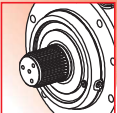

Ø65

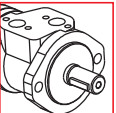

58X53
DIN 5482

INPUT

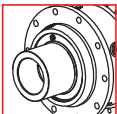

Ø28 - Ø42
Ø65 - Ø1"3/8

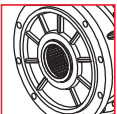

Hydraulic
Motor

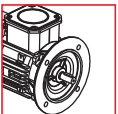

Ø75

58X53
DIN 5482

PLB

Electric
Motor

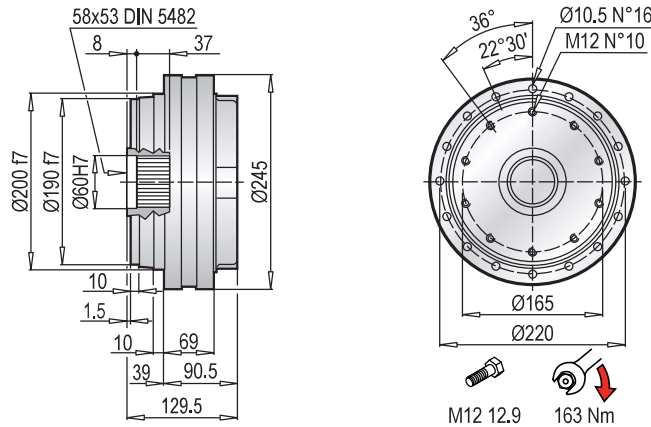
Brake



Aksesuarlar
Accessories
Zubehör
Accessori
Accessoires
Accesorios

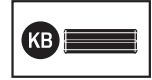

PL 5000 F - Elektrik Motor Adaptörleri (IEC) / Electric Motor Couplings (IEC) / Anbauvorrichtung Für Elektromotore (IEC) / Predisposizioni Per Motori Elettrici (IEC) / Adaptations Pour Moteurs Electriques (IEC) / Acoplamientos Para Motores Eléctricos (IEC)

PL	IEC 63			IEC 71			IEC 80			IEC 90			IEC 100		
	L _T	Z	ØD	L _T	Z	ØD	L _T	Z	ØD	L _T	Z	ØD	L _T	Z	ØD
5001	126.5	36	140	126.5	36	160	146.5	56	200	146.5	56	200	156.5	66	250
5002	187.5			187.5			207.5			207.5			217.5		
5003	235.5			235.5			255.5			255.5			265.5		
5004	283.5			283.5			303.5			303.5			313.5		

PL	IEC 112			IEC 132			IEC 160			IEC 180		
	L _T	Z	ØD	L _T	Z	ØD	L _T	Z	ØD	L _T	Z	ØD
5001	156.5	66	250	190.5	100	300	229.5	139	350	229.5	139	350
5002	217.5			251.5			290.5			-		
5003	265.5			299.5			338.5			-		
5004	313.5			347.5			-			-		

PL	IEC ~ Kg								
	63	71	80	90	100	112	132	160	180
5001	31	31	33	33	34	34	38	48	48
5002	38	38	40	40	41	41	45	55	-
5003	44	44	46	46	47	47	51	61	-
5004	50	50	52	52	53	53	-	-	-

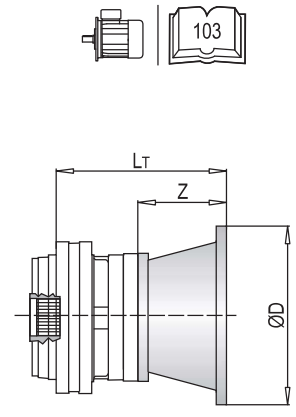

PL 5000 F - Giriş Milleri / Input Shafts / Antriebswellen / Alberi Entrata / Arbres D'entree / Ejes De Entrada

PL	EL C 28				EL C 42				EML 42				EML 1"3/8 Z6				EM 65				EM 1"3/8 Z6			
	L _T	Z	L	Ød	L _T	Z	L	Ød	L _T	Z	L	Ød	L _T	Z	L	Ød	L _T	Z	L	Ød	L _T	Z	L	Ød
5001	154.5	64	50	28	154.5	64	82	42	184.5	94	82	42	184.5	94	106	1"3/8	225.5	121.5	105	65	225.5	121.5	105	1"3/8
5002	215.5				215.5				245.5				245.5				-				-			
5003	263.5				263.5				293.5				293.5				-				-			
5004	311.5				311.5				341.5				341.5				-				-			

PL	EP 65				PL	~ Kg						
	L _T	Z	L	Ød		EL C 28	EL C 42	EML 42	EML 1"3/8 Z6	EM 65	EM 1"3/8 Z6	EP 65
5001	257	153	105	65	5001	31.5	32.0	35.0	35.0	43.0	43.0	52.0
5002	-	-	-	-	5002	38.5	39.0	42.0	42.0	-	-	-
5003	-	-	-	-	5003	44.5	45.0	48.0	48.0	-	-	-
5004	-	-	-	-	5004	50.5	51.0	54.0	54.0	-	-	-

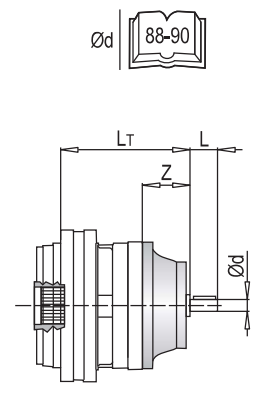

PL 5000 F - Sonsuz Dişli Redüktör Adaptörleri (PMRV/PRV) / Worm Gearbox Adaptors (PMRV/PRV) / Anschluss Für Schneckengetriebe (PMRV/PRV) / Predisposizioni Per Riduttori A Vite Senza Fine (PMRV/PRV) / Adaptation Pour Reducteurs A Vis Sans Fin (PMRV/PRV) / Acoplamiento Para Reductores De Tornillo Sin Fin (PMRV/PRV)

PL	PMRV/PRV 050					PMRV/PRV 063					PMRV/PRV 075				
	LM	I	h	MA	G	LM	I	h	MA	G	LM	I	h	MA	G
5001	216	50	110	60	80	225.5	63	135	72	95	204.5	75	161	86	112.5
5002	277					286.5					265.5				
5003	285					334.5					313.5				
5004	373					382.5					361.5				

PL	PMRV/PRV 090					PMRV/PRV 110					PMRV/PRV 130				
	LM	I	h	MA	G	LM	I	h	MA	G	LM	I	h	MA	G
5001	214.5	90	193	103	129.5	242	110	237.5	127.5	160	249.5	130	277.5	147.5	180
5002	275.5					-					-				
5003	323.5					-					-				
5004	371.5					-					-				

PL	PMRV/PRV ~ Kg					
	050	063	075	090	110	130
5001	34	37.5	40	45	72	89
5002	41	44.5	47	52	-	-
5003	47	50.5	53	58	-	-
5004	53	56.5	59	64	-	-

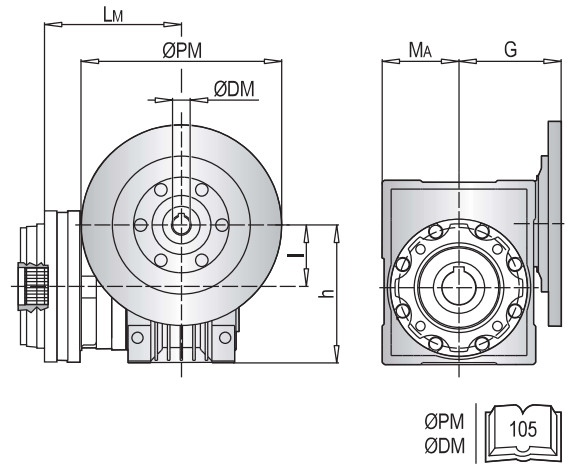

PLB 5000 F - Elektrik Motor Adaptörleri (IEC) / Electric Motor Couplings (IEC) / Anbauvorrichtung Für Elektromotore (IEC) / Predisposizioni Per Motori Elettrici (IEC) / Adaptations Pour Moteurs Electriques (IEC) / Acoplamientos Para Motores Eléctricos (IEC)

PLB	IEC 80				IEC 90				IEC 100				IEC 112			
	A	L _T	Z	ØD	A	L _T	Z	ØD	A	L _T	Z	ØD	A	L _T	Z	ØD
5002	192	296	56	200	192	296	56	200	192	306	66	250	192	306	66	250
5003	226.5	216			226.5	216			226.5	226			226.5	226		
5004	274.5	274.5			274.5	274.5			274.5	274.5			274.5			

PLB	IEC 132				IEC 160			
	A	L _T	Z	ØD	A	L _T	Z	ØD
5002	192	340	100	300	192	379	139	350
5003	226.5	260			-	-		
5004	274.5	-			-	-		

PLB	IEC ~ Kg					
	80	90	100	112	132	160
5002	51	51	52	52	56	66
5003	58	58	59	59	63	-
5004	64	64	65	65	69	-

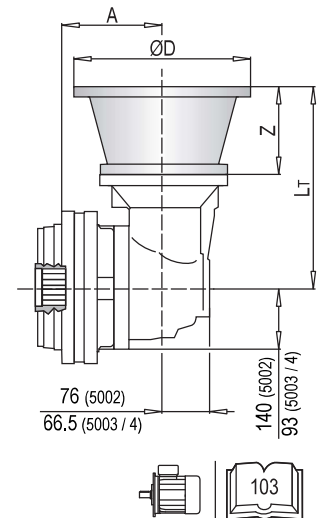

PLB 5000 F - Giriş Milleri / Input Shafts / Antriebswellen / Alberi Entrata / Arbres D'entree / Ejes De Entrada

PLB	EL C 28					EL C 42					EML 42					EML 1"3/8 Z6					EM 65								
	A	L _T	Z	L	Ød	A	L _T	Z	L	Ød	A	L _T	Z	L	Ød	A	L _T	Z	L	Ød	A	L _T	Z	L	Ød				
5002	192	304	64	50	28	192	304	64	82	42	192	334	254	94	82	42	192	334	94	106	1"3/8	192	377.5	121.5	105	65			
5003	226.5	224				226.5	224				226.5	226.5					226.5	226.5				226.5	226.5				226.5	226.5	226.5
5004	274.5	274.5				274.5	274.5				274.5	274.5					274.5	274.5				274.5	274.5				274.5	274.5	274.5

PLB	EM 1"3/8 Z6					EP 65					
	A	L _T	Z	L	Ød	A	L _T	Z	L	Ød	
5002	192	377.5	121.5	105	1"3/8	192	409	329	153	105	65
5003	226.5	297.5				226.5	329				
5004	274.5	274.5				274.5	274.5				

PLB	~ Kg						
	EL C 28	EL C 42	EML 42	EML 1"3/8 Z6	EM 65	EM 1"3/8 Z6	EP 65
5002	49.5	50.0	53.0	53.0	61.0	61.0	70.0
5003	56.5	57.0	60.0	60.0	68.0	68.0	77.0
5004	62.5	63.0	66.0	66.0	74.0	74.0	83.0

